This paper was awarded in the II International Competition (1993/94) "First Step to Nobel Prize in Physics" and published in the competition proceedings (*Acta Phys. Pol. A* **88** Supplement, S-9 (1995)). The paper is reproduced here due to kind agreement of the Editorial Board of "Acta Physica Polonica A".

A HOME-MADE ACCELERATOR

CAN ALTINELLER

Kadikoy Anadolu Lisesi, Dr. Esat Isık Cad., Moda, Istanbul, Turkiye

Abstract

The topic discussed within this paper is a construction of an accelerator with amateur gadgets. The aim was the understanding of the research capabilities of such device. Nearly all equipment was supplied from the hobby market. Some experiments were carried out, and the results are presented; also some tips about construction are presented.

PACS numbers: 29.17.+w

1. Introduction

Electrostatic accelerators play a considerable role in nuclear physics. The essential part of such an accelerator is an evacuated insulating vessel usually referred to as the tube where ions (mostly positive) encounter a negative potential gradient and thus reach very high speed before impinging on the target, where they trigger nuclear reactions. A common ion source is a self-sustaining discharge in rarefied hydrogen, deuterium or helium confined in a separate bulb communicating with the main tube by a pinhole. An auxiliary voltage shoots ions through the pinhole while neutral molecules having only thermal velocities escape more slowly so that vacuum can be maintained by powerful pumps.

The principal data for such a device are the accelerating voltage and the ion beam current which respectively determine the ultimate kinetic energy of the ions and the number of ions accelerated per second. The accelerating voltage has an essential bearing on the likelihood of nuclear reactions.

2. Design and construction

2.1. The accelerating tube

The tube consists of three rings sandwiched between small glass pipes. The rings and the tube is shown in Fig. 1. Glass pipes of eight centimeters length were epoxied to aluminium rings. At each end of the tube a flange is seated for mounting the target holder and the ion source. A critical point in the construction of the tube is the epoxy used. Usually epoxies with long setting times give better results in vacuum work. Ours

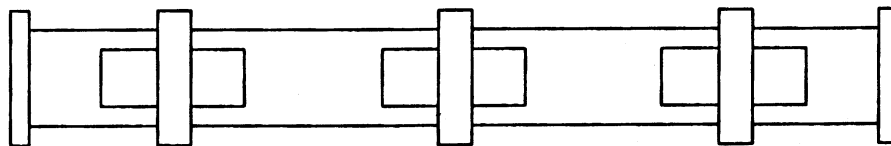

Fig. 1. The accelerating tube.

was Bison 5 min Epoxy and it worked quite well. We have discovered that if the whole assembly is heat treated at about 50°C after the epoxy is hardened it gives better results. This process is done by a wooden box which is heated by incandescent lamps.

The role of the rings is to keep the potential gradient constant all over the tube. The ion source is connected to one side and the target holder to the other side and high voltage is applied between the target holder and ion source.

The tube keeps the vacuum for a few minutes. Later it degasses because aluminium is not a good vacuum metal and it was not surface cleaned. However, metals with low atomic weight must be used to reduce the X-ray production.

2.2. The ion source

A flange made of aluminium having an internal diameter of 2 mm and outside diameter of 50 mm was drilled in the middle for a depth of 3 mm by 18 mm drill chuck. A glass pipe was epoxied inside the 18 mm hole. The other end of the pipe was capped by a kestamyde piece and was fitted with a union.

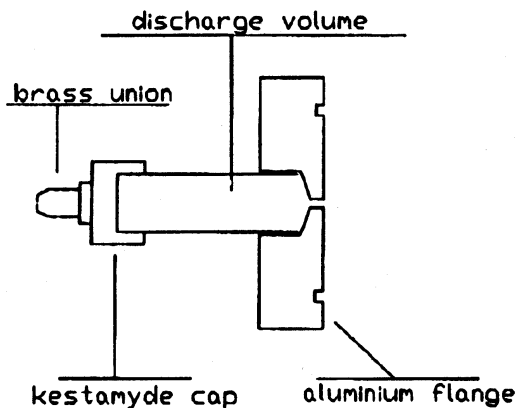

Fig. 2. The ion source.

The ion source assembly is shown in Fig. 2. When the union is connected to positive pole of an induction coil and the flange with 2 mm hole to the negative pole, electrons are pulled by union from the other electrode. When some gas is admitted via copper pipe connected to union, neutral molecules of gas collide with electrons, and ionize them. Positive ions are accelerated to cap and some of them pass through the perforation and continue their way till a collision occurs.

2.3. Target holders

The target end of the tube was made from aluminium. It was 50 mm in diameter and 35 mm in length. A hole 20 mm in diameter and depth of 30 mm was drilled in the centre. It had an o-ring cavity and an union connecting port in the middle for connecting the copper pipe coming from the diffusion pump. It was used when radioactivity measurements were done externally (for γ rays).

For nuclear reaction studies aluminium target holder cannot be used because it heavily shields charged particles. To overcome this problem, a target holder with mica window was designed. It was again of diameter 50 mm and length 35 mm but it was made of kestanymde. Its design was just like the other one but it had a fitting on the other end. The fitting was capped by a plug drilled in the middle by 8 mm. When a target could be shaped like a disk it was inserted between the fitting and the plug with an o-ring. The beam falls directly on one face of the target and other face of the target leads to the atmosphere. When the target cannot be shaped into a disk (it is in form of ribbons or powder) the drilled plug is closed by a mica window. Mica is sold by most electronic stores as an insulator. The target material is laid on the window and the plug is screwed into position. Both target holders are shown in Fig. 3a and Fig. 3b.

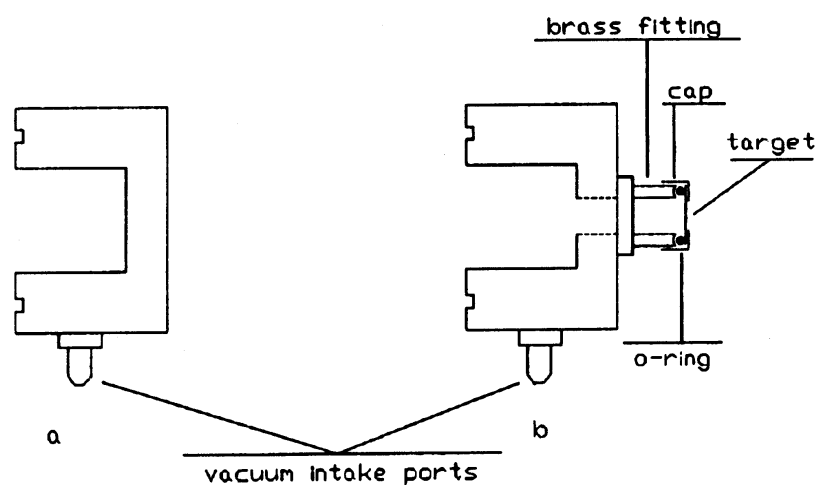

Fig. 3. The target holders.

2.4. The high-voltage unit

In all types of television sets both colour and black-white, an oscillator drives the horizontal sweep and high voltage assembly. The frequency of the oscillator is about 16 kHz. All parts were cheap and easy to find so we built the high-voltage unit by using television parts. We designed a driver unit whose schematic is given in Fig. 4. The flybacks (E.H.T. transformer is called flyback in electronics) that we used consisted of a primary and secondary circuits, two built-in high-voltage diodes, a middle lead on the secondary circuit rated at 10,000 volts, and a bleeder resistor taking place between the 26,500 V output and the 10,000 V output. Complex flybacks (e.g. Sony, Grundig, JVC) have many additional windings. The driver consists of a power transistor (BU508D) driven via base by a signal generator over an isolation transformer having a 3 to 2 ratio. The collector of the transistor is connected to one end of the primary windings over a choke coil having an inductance of 33 μ H. The other end of the primary is connected to +150 V dc provided by a low voltage supply. The 150 V dc power supply is made by using a common household 220 to 110 volt transformer. The transformer is fed with 220 V ac and the output (110 V ac) is rectified by a diode bridge and filtered by a 300 μ F condenser. A diode (1N4007) connected in reverse direction to the current completes the power supply. Schematic of the whole high-voltage unit is given in Fig. 4.

Four flybacks were sandwiched between glass plates and glued into position by means of epoxy. After it dried a third plate was mounted at the bottom. The output voltage can be slightly adjusted by changing the frequency, amplitude and the wave pattern

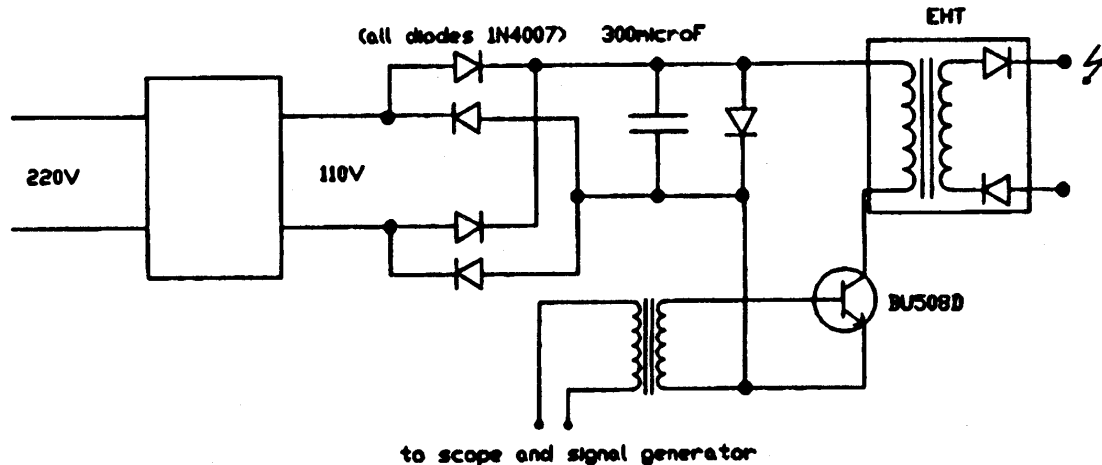

Fig. 4. The high-voltage unit.

respectively. The voltage was measured by a high-voltage probe and all the units were set to maximum output.

Besides this by cancelling desired number of flybacks the output can be rated to 53 kV, 79.5 kV, and 106 kV. The driver unit drives four modulators at the same time. This procedure is accompanied by connecting the primary windings of flybacks in parallel.

2.5. The vacuum system

The tube has to be evacuated to a pressure of $0.01 \mu\text{m Hg}$. This type of vacuum is referred to as high vacuum and usually obtained by diffusion pumping. A diffusion pump was supplied from a local CRT restorer as a junk and it was fully revised by using conventional vacuum methods. One of the problem with the pump was that it had no vapor holder. A vapor holder is a device inserted in a small chamber that is connected to the backing pump. Its mission is preventing oil vapors from the backing pump from reaching the diffusion pump. Usually vapor holders are made from molecular zeolites but we was unable to get one. We tried compressed metal scrap-like dish-washing wires and they performed very well.

We used ordinary copper pipes and copper pipe connecting unions that were not vacuum tight unless an o-ring was placed between the countersink and the brass union. Not only o-ring is enough for this purpose, the union's threads have to be wrapped with thread sealing teflon tape and the whole assembly has to be coated with epoxy cement. The procedure is irreversible but non-leaking in high vacuum.

The pump heats up in 30 min and evacuates the whole tube in about 40 min down to $0.01 \mu\text{m Hg}$. But when some gas is admitted to the tube after the pump is heated up it vacuums the tube from $10 \mu\text{m Hg}$ to $0.01 \mu\text{m Hg}$ in a matter of seconds.

2.6. Vacuum gauging

Conventional vacuum gauges were well beyond the reach of us. After some search we build one from materials easy to find around the house. A Ni-Cr wire was bent into a 1 to 2 cm rectangle and two chrome plates were spot welded to U-shaped wire. The rectangle was connected to a vacuum tube-header and the plates were connected to the one of the free electrodes of the header. The whole assembly was encapsulated by a 30 mm diameter glass pipe and it was epoxied to the liners of header. The gauge is drawn in Fig. 5.

The circuitry of the vacuum gauge was easy. 2000 volts from an auxiliary power supply is being stabilized by 39 fifty volt Zener diodes connected in series and a current limiting

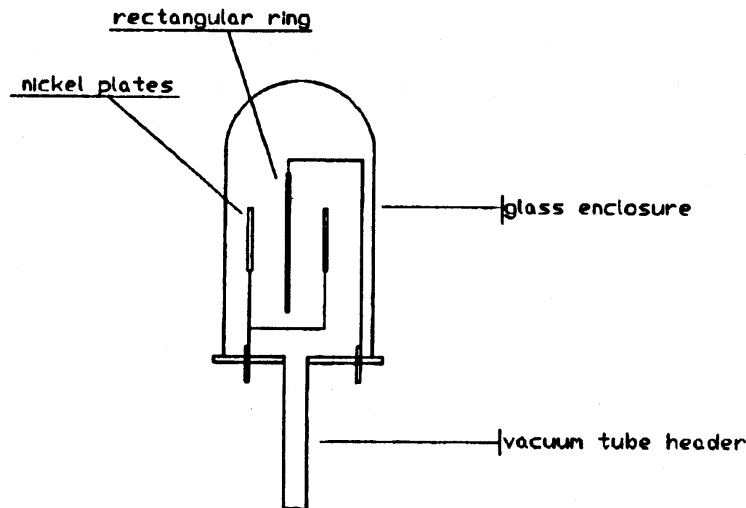

Fig. 5. The home-made vacuum gauge.

resistor of 200 k Ω . The current flows into the tube and a microamperometer are connected in series. Pressure is directly read on the microamperometer. Absolute pressure values cannot be obtained from the gauge unless it is calibrated with a commercial one but it can be used to compare different levels of vacuum and this helps to detect a leak easily.

2.7. Introduction of gases to vacua

We used two different kind of gases, helium in order to obtain α particles and hydrogen for getting protons. Helium was sold in big tubes pressurized at 200 atm, and tubes were returned to the gas company with a pressure of 2 atm. The first company we asked for filled our tube free of charge by using a simple connector. We had a smaller tube which was manufactured for storing CFC's and which was previously vacuumed.

The gas rushing out of the regulator at 100 mm Hg meets a second regulator consisting of two gas valves attached to a plastic rod that is drilled by 7 mm all the length acting as a capillary.

For obtaining hydrogen a balloon flask is filled with HCl and a rubber stopper connected to a drying column consisting of calcium chloride and phosphorus pentoxide is plunged into the mouth of the flask. Then mechanical pump is switched on and the assembly is washed with hydrogen till the reaction ends by opening all the vanes. After this the vanes are closed and the assembly is put out of use. There is enough gas inside the capillary for filling the tube many times.

3. Experiments with the accelerator

3.1. Determination of the beam current

There are two methods for calculating the beam current; one of them is a theoretical calculation based upon the current of the high-voltage generator and the other is the experimental method. The theoretical method suggests that the beam current is equal to the current of the high-voltage generator if the ion source can satisfactorily supply ions to the accelerator. But imperfections in the tube and collisions occurring between the gas atoms and the ions make this calculation questionable. Also current output of my electrostatic generator is practically not known.

The experimental method for determining the beam current is letting the beam fall into

an assembly called Faraday cup and connecting this cup to the ground over a microammeter therefore grounding the minus end of the electrostatic generator and connecting the target end to the ground over the microammeter.

When the apparatus was energized the microammeter gave me a reading of about $19 \mu\text{A}$ for both protons and α particles. The main reason for this result can be explained by

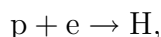
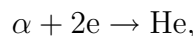

each α particle falling on the target plate causes an ionization and pulls two electrons from the ground. Similarly each proton falling on the target results with capture of an electron from the ground.

The particles accelerated per second is found by the formulas

$$I = dQ/dT,$$

$$Q = ne,$$

where I , Q , T , and n are the current, charge, time, and the number of ions accelerated per second, respectively.

Rewriting the previous equation in other terms

$$n = IdT/eZ,$$

where n is the number of accelerated particles per unit time, I is the current read on the microammeter, e is the elementary charge, and Z is the charge number of the accelerated ion.

Numerical values of the accelerator are

$$n_{\alpha} = 5.933 \times 10^{13} \quad \text{particles per second},$$

$$n_p = 1.186 \times 10^{14} \quad \text{particles per second},$$

3.2. Bombardment of fluorine minerals with protons

When fluorine is bombarded with protons intense γ rays are emitted. The energy brought by the accelerator turns into γ rays after the collision

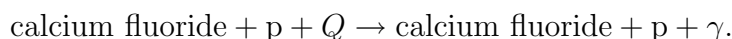

Usually in this kind of reactions γ -ray energy is near the value of the energy brought by the accelerator. The rest of the energy is the energy of the proton after the collision. The reaction occurs with a very small probability. The results are graphically illustrated in Fig. 6.

3.3. Bombardment of borax with protons

The reaction mechanism is the same for the previously mentioned procedure, but the output intensity is much higher. Figure 7 illustrates the results obtained.

3.4. Bombardment of carbon with α particles

In the literature the reaction of carbon bombarded by helium nuclei takes place as follows:



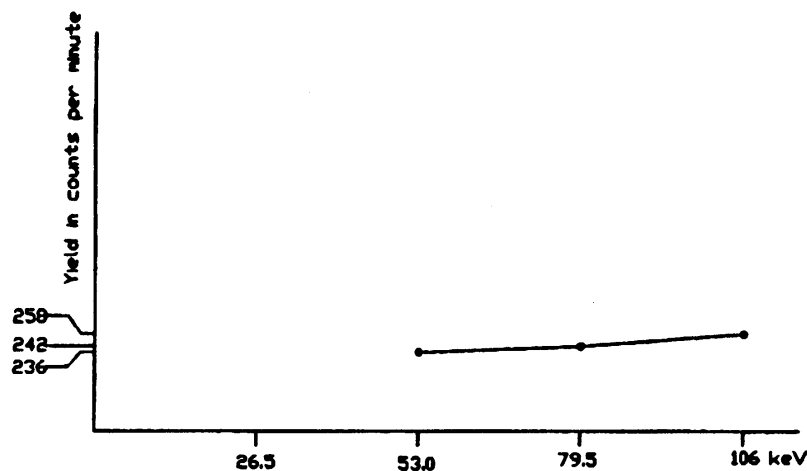

Fig. 6. Yield from proton bombardment of calcium fluoride.

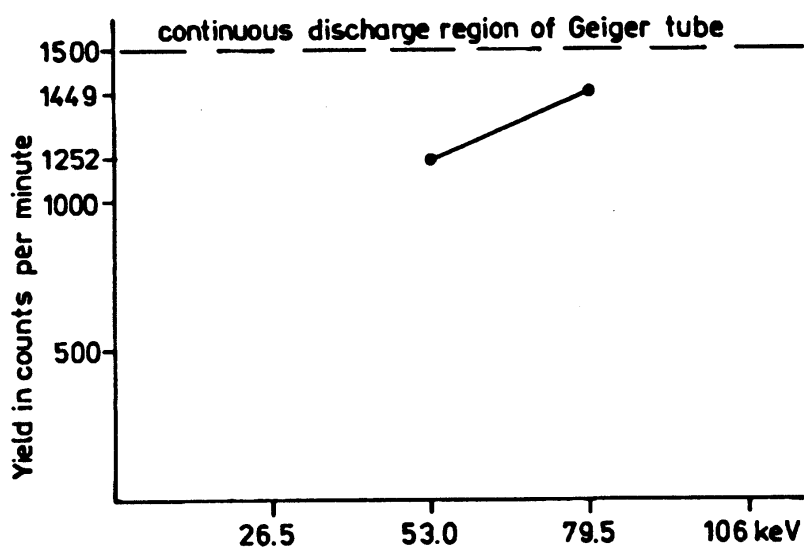

Fig. 7. Yield from proton bombardment of borax.

The reaction has a Q value of 7.15 MeV. At low energies like in my case the reaction probability is extremely small. We had tried any element in my accelerator and none of them gave nothing else than noise but carbon gave a bit more than noise.

The average yield from the reaction is 144 count/minute and we are not sure if it is noise or not. The calculated cross-section for the reaction is extremely low. Nearly all the elements up to atomic weight 30 were bombarded with my accelerator in many forms and carbon was the only one that we were able to detect some output.

We think it should be wrong to discuss this reaction quantitatively because the ion source provides both He^{++} and He^+ ions. Also the gases, especially hydrogen was not pure.

4. Conclusion

The research capability of this kind of device is limited. But its compactness may supply some advantages in some cases. Compared to full scale devices it is a toy, nevertheless it was an enterprising project which acted on the purpose of gaining some experience on scientific work.

Acknowledgments

I would like to thank my physics teacher Nursen Denizoz, who supplied me a room in the school as a subdivision of the main lab, also who let me use the equipment in the labs. Some parts were made in Tubitak Marmara Research Centre. I also would like to thank Niyazi Parlar for his support in my work.